



HVLP Spray Guns

Instruction Manual



INTRODUCTION

It is the owner and/or operator's responsibility to study all WARNINGS, operating, and maintenance instructions contained on the product label and instruction manual prior to operation of this spray gun. The owner/operator shall retain product instructions for future reference.

The owner and/or operator are responsible for maintenance, maintaining all decals or warning labels and while in use, maintaining the unit in good working order. If the owner and/or operator are not fluent in English, the product warnings and instructions shall be read and discussed with the operator's native language by the purchaser/owner or his designee. Make sure that the operator comprehends its contents. Safety information shall be emphasized and understood prior to usage. The spray gun shall be inspected per the operating instructions.

Users of this spray gun must fully understand these instructions. Each person operating this spray gun must also be of sound mind and body and must not be under the influence of any substance that might impair their vision, dexterity, or judgment.

Protect yourself and others by observing all safety information.

Failure to comply with instructions could result in personal injury and/or property damage!

If you encounter any problems or difficulties, please contact our customer service department at:

1-800-386-0191

This instruction manual is intended for your benefit. Please read and follow the safety, installation, maintenance and troubleshooting steps described within to ensure your safety and satisfaction. The contents of this instruction manual are based upon the latest product information available at the time of publication. The manufacturer reserves the right to make product changes at any time without notice.

SAFETY ALERT

⚠ WARNING Read and understand this entire instruction manual before attempting to assemble, install, operate or maintain this spray gun. Failure to comply with the instructions may result in serious personal injury and/or property damage!

The following signal words are used to emphasize safety warnings that must be followed when using this product:

⚠ DANGER Indicates an imminently hazardous situation that, if not avoided, WILL result in death or serious injury.

⚠ WARNING Indicates a potentially hazardous situation that, if not avoided, COULD result in death or serious injury.

⚠ CAUTION Indicates a potentially hazardous situation that, if not avoided, MAY result in minor or moderate injury.

⚠ NOTICE Indicates important information, which if not followed, MAY cause damage to equipment.

UNPACKING & INSPECTION

After opening the carton, unpack your new spray gun and related parts & accessories. Please inspect it carefully for any damage that may have occurred during transit. Please check it against the photograph on carton. If any parts are missing, please call factory customer service at 1-800-386-0191.

⚠ WARNING Do not operate this spray gun if damaged during shipment, handling or misuse. Do not operate the spray gun until the parts have been replaced or the fault rectified. Failure to do so may result in serious personal injury or property damage.

All damaged parts must be repaired or replaced as needed prior to operating this spray gun.

Check to see that all nuts, bolts and fittings are secure before putting this tool into service. If you have any questions, or require assistance with damaged or missing parts, please contact our factory customer service department at:
1-800-386-0191

Please have the model number, and date of purchase available for reference when calling.

MODEL NUMBER: _____

DATE of PURCHASE: _____

IMPORTANT SAFETY RULES FOR ALL SPRAY GUNS

SAVE THESE INSTRUCTIONS





WARNING Read and understand all instructions. Failure to follow all instructions included with this product could result in serious personal injury and/or property damage.

Follow all local electrical and safety codes as well as in the United States, the National Electrical Codes (NEC) and the Occupational Safety and Health Act (OSHA).



WARNING The following hazards can occur during the normal use of this product:

HAZARD		 	
Risk of explosion or fire - flammable materials			
WHAT COULD HAPPEN	HOW TO PREVENT IT		
When paints or materials are sprayed, they are broken into very small particles and mixed with air. This will cause certain paints and materials to become extremely flammable and could result in serious injury or death.	<p>Never spray closer than 25 feet to the air compressor! Motors, electrical equipment and controls can cause electrical arcs that will ignite a flammable gas or vapor. Never store flammable liquids or gases in the vicinity of the compressor. If possible, locate the air compressor in separate room. Never spray into compressor, compressor controls or the motor.</p> <p>Never spray near open flames or pilot lights in stoves or heaters.</p> <p>Never smoke or eat while spraying paint, insecticides, or other flammable substances.</p> <p>Provide ample ventilation when spraying indoors.</p> <p>To reduce the risk of static sparking, grounding continuity to the spray equipment and the object being sprayed must be maintained.</p> <p>When spraying and cleaning, always follow the instructions and safety precautions provided by the material manufacturer (Refer to MSDS)</p>		

HAZARD			
Risk of explosion - incompatible materials			
WHAT COULD HAPPEN	HOW TO PREVENT IT		
Halogenated hydrocarbon solvents such as 1,1,1-Trichloroethane and Methylene Chloride can chemically react with the aluminum used in most spray equipment, and this gun and cup, to produce an explosion hazard and could result in serious injury or death.	<p>Read the label or data sheet for the material you intend to spray.</p> <ol style="list-style-type: none"> Never use any type of spray coating material containing these solvents. Never use these solvents for equipment cleaning or flushing. If in doubt as to whether a material is compatible, contact your material supplier. 		

HAZARD			
Risk of breathing			
WHAT COULD HAPPEN	HOW TO PREVENT IT		
<p>Some paints, coatings and solvents may cause lung damage, and burns if inhaled or allowed to come into contact with skin or eyes.</p> <p>Spraying of some organic solvents can cause intoxication and serious damage to health.</p> <p>Do not spray acids, corrosive materials, toxic chemicals, fertilizers or pesticides. Using these materials could result in death or serious injury.</p>	<p>Use a NIOSH approved mask or respirator and protective clothing designed for use with your specific application and spray materials. Some masks provide only limited protection against toxic materials and harmful paint solvent. Consult with a Safety Expert or Industrial Hygienist if uncertain about your equipment or materials.</p> <p>Use the spray gun in well-ventilated areas.</p> <p>Keep visitors away and NEVER allow children or pets in the work area.</p>		

IMPORTANT SAFETY RULES FOR ALL SPRAY GUNS

SAVE THESE INSTRUCTIONS

HAZARD			
Risk of flying objects			
WHAT COULD HAPPEN	HOW TO PREVENT IT		
<p>Certain parts are under pressure whenever the gun is connected to a pressurized air line. These parts may be propelled if the gun is disassembled.</p> <p>Compressed air may propel dirt, metal shavings, etc. and possibly cause an injury and/or damage to the workpiece.</p> <p>Prolonged exposure to air spray can result in permanent damage to hearing.</p>	<p>Disconnect the gun from the air line, or completely depressurize the air line whenever the gun is to be disassembled.</p> <p>Never point any nozzle or sprayer toward a person or part of the body.</p> <p>Always wear ANSI 278.1 safety approved goggles or glasses when spraying.</p> <p>Always work in a clean environment. Do not aim the spray gun at any dust of debris.</p> <p>Always wear hearing protection when operating spray equipment.</p>		

HAZARD			
Risk of injection			
WHAT COULD HAPPEN	HOW TO PREVENT IT		
<p>Spray guns operate at pressures and velocities high enough to penetrate human and animal flesh, which could result in amputation or other serious injury.</p> <p>See a physician immediately!</p>	<p>Never place hands in front of nozzle.</p> <p>Direct spray away from self and others.</p>		

HAZARD			
Risk of bursting			
WHAT COULD HAPPEN	HOW TO PREVENT IT		
<p>Exceeding the pressure rating of air tools, spray guns, air operated accessories, tires, and other inflatables can cause them to explode or fly apart, and could result in serious injury.</p>	<p>Do not use pressure that exceeds the operating pressure of any of the parts (hoses, fittings, etc.) in the painting system.</p> <p>Keep hose away from sharp objects. Bursting air hoses may cause injury.</p> <p>Examine air hoses regularly and replace if damaged.</p> <p>Always use a pressure regulator on the air supply to the spray gun.</p>		

WORK AREA SAFETY

⚠ CAUTION Before disassembly or removal of any part of gun or attached components, shut off air supply to gun, shut off air compressor, release pressure from spray gun by depressing trigger, and disconnect power source. NEVER assume system pressure is zero.

⚠ WARNING TO AVOID CREATING AN EXPLOSIVE ATMOSPHERE, WORK ONLY IN WELL VENTILATED AREAS.

⚠ WARNING ALWAYS USE A RESPIRATOR THAT MEETS OSHA/NIOSH REGULATIONS TO PREVENT INHALATION OF TOXIC MATERIAL.

1. Keep your work area clean and well lit. Clutter and dark areas invite accidents.
2. Do not operate air compressor or other power tools in explosive atmospheres, such as in the presence of flammable liquids, gases, or dust. Electric motors used in these machines create sparks which may ignite the dust or fumes.
3. Keep pets, bystanders, children, and visitors away while operating a spray gun.

FEATURES AND SPECIFICATIONS

- 1) 600ml Aluminum Paint Cup
- 2) Fluid Inlet (Optional Material Filter)
- 3) Air Cap
- 4) Fluid Tip (Nozzle)
- 5) Trigger
- 6) Packing Nut (Air Valve)
- 7) Air Control Knob
- 8) Cup Lid
- 9) Fluid Needle
- 10) Fluid Control Knob
- 11) Spray Pattern Control Knob
- 12) 1/4" NPS Air Inlet Fitting

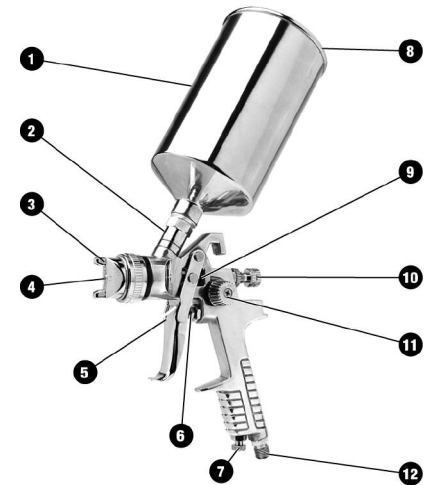

INTRODUCTION

Your new TEKZ® spray gun is a vital link in the finishing application. In addition to operating the spray gun properly, techniques of surface preparation, paint preparation and the nature of the specific spray material to be used must be understood. These instructions will explain the differences among various spray methods and serve as a guide in the proper operation and techniques of spray painting. Please refer to the Parts section of this manual for model specific information.

TYPES OF SPRAY GUNS

There are three basic types of spray guns: siphon feed, pressure feed, and gravity feed. The type of spray gun used depends upon the application and the size of the project. These types of spray guns can be either “conventional” spray or HVLP (High Volume Low Pressure) spray.

Conventional spray guns use a much higher air cap pressure (more than 10 PSI) to atomize the paint than is used by HVLP spray guns which results in more overspray and lower transfer efficiency. (Transfer efficiency refers to the percentage of paint sprayed that actually adheres to the surface being painted).

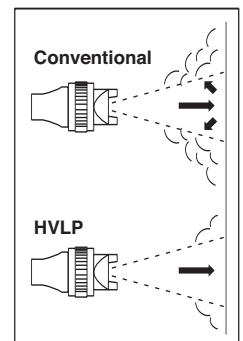

HVLP, electrostatic and airless paint spray guns are the only spray methods that meet the strict 65% transfer efficiency rate required by some air quality district regulations. This improved transfer efficiency results in a significant material savings when compared to conventional spray guns. Be sure to check local, state and national regulations that may apply before performing any spraying operations.

In order to qualify as an HVLP spray gun, dynamic air pressure, when measured at the air cap, must not exceed 10 PSI. HVLP Spray guns produce a soft, low velocity spray pattern which provides increased control while reducing paint “bounce-back” and overspray. As a result, HVLP is also well suited for spraying surfaces with recessed areas.

TYPES OF SPRAY GUN HOOKUPS

SIPHON FEED CUP HOOKUP

Air pressure for atomization is controlled by the regulator on the air source. The amount of fluid is adjusted by the fluid control knob on the gun, the paint viscosity, and the air pressure. The siphon cup must be vented to the atmosphere.

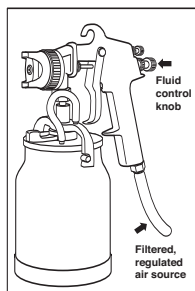

PRESSURE FEED CUP HOOKUP

Air pressure for atomization is controlled by the regulator on the air source. The fluid pressure is set by adjusting the cup regulator. The amount of fluid is also adjusted by the fluid control knob. This method is required for heavy fluids and when using internal mix nozzle spraying. This method generally requires a special fluid tip, needle and air cap set.

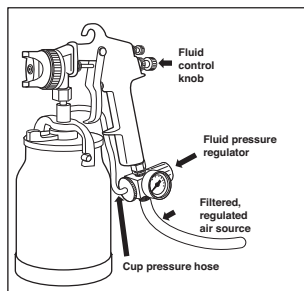

PRESSURE FEED TANK HOOKUP

This method is similar to the pressure feed cup hookup with the added benefit of being able to orient the gun in any position independent of the tank. This method is useful for medium production or large scale spraying applications where large quantities of paint are used.

For medium production spraying (single regulator setup on tank), air pressure for atomization is controlled by the regulator at the air source. The amount of fluid is adjusted by the regulator on the paint pressure tank.

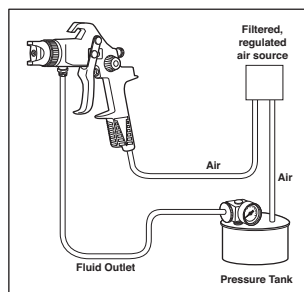

For portable painting operations (double regulator setup on tank), air pressure for atomization and fluid supply is regulated by two individual air regulators on the paint pressure tank.

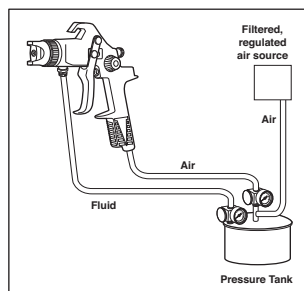

PRESSURE FEED CIRCULATING HOOKUP

For heavy production spraying, air pressure for atomization is controlled by the regulator on the air source. The fluid pressure is regulated by a separate fluid regulator at the bulk paint source.

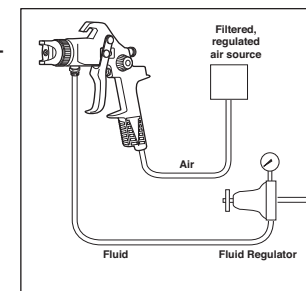

GRAVITY FEED CUP HOOKUP

This popular method is similar to the siphon feed with cup except that the paint cup is mounted above the spray gun. This creates a positive fluid pressure in the fluid nozzle while providing better balance and comfort for the operator.

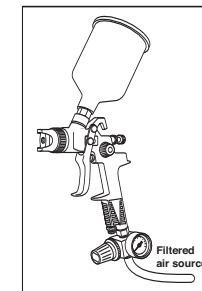

ASSEMBLY

⚠ NOTICE All parts on a spray gun should be screwed in hand tight at first; this will avoid the possibility of cross threading the parts. If the parts can not be turned by hand easily, make sure you have the correct parts, unscrew by hand easily, make sure you have the correct parts, unscrew, realign, and try again. NEVER use undue force in mating parts.

- 1) Connect the paint cup to the fluid inlet nipple and tighten to ensure a good seal, using spanner. Use of the supplied filter screen is optional. This filter helps protect against small particle contaminants. See parts drawing for proper filter placement.
- 2) Wrap the threads on the air inlet nipples of the spray gun and the regulator with a couple of layers of PTFE tape to help prevent air leaks.
- 3) Connect the regulator to the air inlet nipple at the base of the gun handle.
- 4) Connect the air supply to the air inlet nipple on the regulator.

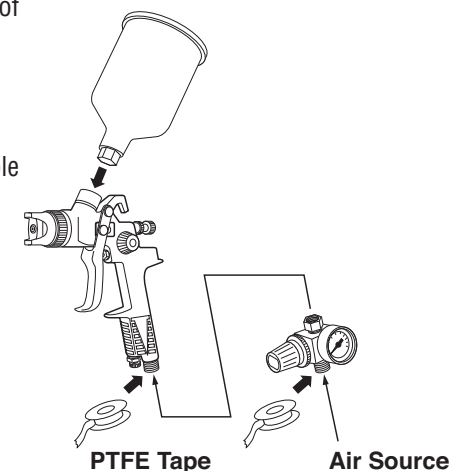

PREPARATION FOR SPRAYING

⚠ WARNING DO NOT ATTEMPT TO UNCLOG (BACK FLUSH) SPRAY GUN BY SQUEEZING TRIGGER WHILE HOLDING FINGER IN FRONT OF FLUID NOZZLE

⚠ CAUTION Pressure may vary according to viscosity of material used. Maximum working pressure of this gun is 100 PSI. DO NOT EXCEED PRESSURE LIMIT OF GUN OR ANY COMPONENT IN THE SYSTEM.

⚠ CAUTION Prior to daily operation, make certain that all connections and fittings are secure. Check hose and all connections for weak or worn conditions that could render the system unsafe. All replacement components must have a working pressure equal or greater than the system pressure.

⚠ NOTICE This spray gun was treated with an anticorrosive agent prior to shipment. CAREFULLY FLUSH GUN WITH THINNER BEFORE USE.

WATER AND/OR OIL IN COMPRESSED AIR

All compressor pumps discharge some condensed water, oil or contaminants with the compressed air. **IMPORTANT:** This condensation will cause “fish eyes” to appear in the paint job. Install appropriate water/oil removal filter equipment and controls as necessary for the intended application.

⚠ NOTICE Failure to install appropriate water/oil removal equipment may result in damage to machinery or workpiece.

- 1) Thoroughly mix paint to be sprayed in accordance with the manufacturer's instructions, adding thinner where necessary.
- 2) Strain material through 60 to 90 mesh screen.
- 3) Fill the gravity feed paint cup with the material. Be careful not to overfill the cup. Install cup lid and make sure vent hole is clear.
- 4) Attach 1/4" NPS (F) air outlet of locking pressure regulator to 1/4" NPS air inlet on spray gun.
- 5) Attach air supply to 1/4" NPT (M) air inlet on locking pressure regulator.

⚠ CAUTION NEVER point spray gun at self or others. Accidental discharge of material may result in serious injury.

- 5) Start the air compressor.
- 6) Adjust air pressure via air supply regulator. **NOTE: HVLP operation requires a maximum of 10 PSI measured at the nozzle. DO NOT exceed 21 PSI at the air inlet to avoid exceeding 10 PSI nozzle pressure.**

⚠ WARNING DO NOT exceed 100 PSI Maximum pressure

- 7) Prepare a piece of scrap material for use as a spray gun test target.
- 8) Depress spray gun trigger fully to spray material.
NOTE: Depressing trigger partially will cause only air to be released.

- 9) Adjust the air pressure and paint flow to provide a uniform dispersion of atomized paint throughout the pattern. Keep air pressure as low as possible to minimize paint “bounce back” and overspray. Excessive fluid flow will result in a heavy center spray pattern. Inadequate flows will cause the spray pattern to split. Please see the Troubleshooting section of this guide if any problems occur.

FAN DIRECTION

The position of the air cap horns determines the direction of the fan (horizontal or vertical spray pattern). Loosen the lock ring on the air cap and rotate the horns to achieve the desired pattern. Hand tighten lock ring after adjustment.

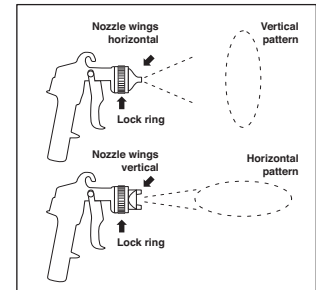

SPRAY PATTERN ADJUSTMENT

SIPHON AND GRAVITY FEED GUNS

- 1) Adjust air pressure to the spray gun according to the recommendations supplied by the spray material manufacturer. This air pressure is typically below 20 PSI for HVLP spray guns and between 40 to 60 PSI for conventional spray guns. Adjust air pressure with the trigger pulled and the air control knob (if applicable) fully open.
- 2) The width of the “fan spray” is controlled by the pattern control knob. Turn knob counterclockwise to increase the width of the fan spray pattern. Turn knob clockwise to decrease the spread of the fan spray pattern for a round pattern.
- 3) Trigger a short burst while turning fluid control knob until the desired pattern on the test target and adjust the fluid control knob until the desired atomization (spray) pattern is achieved. If the spray is too fine, creating excessive overspray, there is too much air for the amount of paint being sprayed - Reduce the air pressure or open the fluid control to spray more material. If the spray is too coarse, (spitting globs of paint), reduce the amount of material with the fluid control knob or thin the paint.

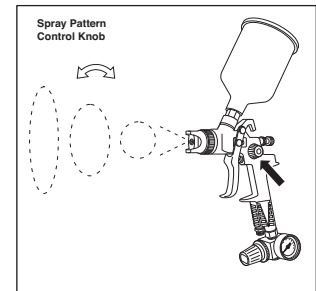

PATTERN ADJUSTMENT FOR PRESSURE HOOKUPS

- 1) Adjust air pressure to the spray gun according to the recommendations supplied by the spray material manufacturer. This air pressure is typically between 40 to 60 PSI for conventional spray guns. Adjust air pressure with the trigger pulled and the air control knob (if applicable) fully open.
- 2) The width of the “fan spray” is controlled by the pattern control knob. Turn knob counterclockwise to increase the width of the fan spray pattern. Turn knob clockwise to decrease the spread of the fan spray pattern for a round pattern.
- 3) Open the fluid control knob by turning counterclockwise about three turns.
- 4) Start the tank pressure at 0 PSI and turn the tank regulator slowly to increase fluid delivery until the desired atomization (spray) pattern is achieved.
- 5) If the spray pattern is too coarse, reduce the tank pressure with the tank regulator to reduce the amount of material. Trigger a short burst to relieve the tank pressure, and then increase tank pressure to slowly until a proper atomization pattern is achieved.
- 6) The fluid control knob can be used for fine adjustment of the atomization pattern.

NOTICE Before spraying the workpiece, practice on a cardboard or other suitable test target to ensure that the spray pattern size and consistency are correct.

GUN HANDLING

For best results, please follow these basic guidelines when spraying:

- 1) Always keep the spray gun perpendicular to the surface being painted.
- 2) Keep the nozzle about 6 to 12 inches from the work surface throughout the stroke.
- 3) Always keep the gun in motion while spraying. Stopping the gun motion in mid-stroke will cause a build up of paint which can cause runs in the finish.
- 4) Do not “fan” the gun in an arcing motion as this creates an uneven finish by producing a build up of paint in the middle portion of the stroke and thinner coating at each end of the stroke.
- 5) Trigger the gun properly - Start the gun moving at the beginning of each stroke BEFORE SQUEEZING THE TRIGGER and release the trigger BEFORE STOPPING GUN MOTION at the end of each stroke.
- 6) The amount of paint being applied to the surface varies due to the speed of the stroke, distance from the work surface, the adjustment of the fluid control knob and the air pressure being used. **NOTE: To reduce overspray and maximize efficiency, always spray with the lowest possible atomizing air pressure.**
- 7) The material deposited should always be even and wet. Overlap each stroke just enough to obtain a uniform finish.
- 8) Use appropriate masking materials (masking paper, tape, etc.) as needed to protect other surfaces from overspray.

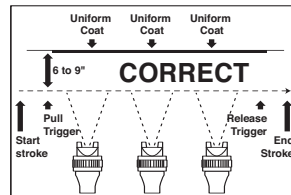
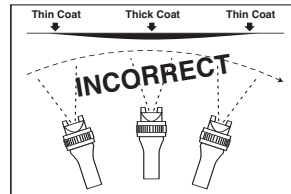

CARE AND MAINTENANCE

WARNING Always wear safety goggles that comply with ANSI standard Z87.1 when cleaning spray guns.

WARNING Always wear a OSHA/NIOSH approved respirator and approved protective clothing designed for use with the specific solvents being used.

CAUTION Always exercise extreme care when using any solvent or thinner. Never clean gun near fire, flame, electrical equipment, or any source of heat or sparks.

CAUTION DO NOT soak entire spray gun in solvent or thinner for a long period of time as this will destroy lubricants and possibly make motion uneven. NEVER use lye or caustic alkaline solution for cleaning. Such solutions will attack and degrade aluminum alloy parts of gun making it unusable.

DAILY CLEANING

NOTICE Clean spray gun immediately after use. Paint and other spray materials dry quickly in the small passages of the gun rendering it unusable due to the difficulty of removing hardened paint from the passages inside the gun.

NOTICE Local codes may not allow the spraying of paint thinner or solvents. Use a gun washer to clean spray guns in accordance with local codes. Follow manufacturer's instructions for proper use of cleaning equipment and materials. Dispose of used cleaning materials in accordance with local, state and national regulations.

CLEANING SPRAY GUNS WITH PAINT CUPS

- 1) Empty paint cup; then rinse with appropriate solvent recommended by the spray material manufacturer.
- 2) Refill paint cup with cleaning solvent and attach to gun. Spray solvent through the gun while shaking the gun. Wipe the exterior of the gun with a solvent soaked rag. Repeat until the gun is clean.
- 3) Remove the air cap and soak in solvent until clean. Use a small bristle brush for stubborn stains. If it becomes necessary to clean the air cap holes, use a toothpick or small brush. Our #19112 Spray Gun Cleaning Kit provides an assortment of cleaning brushes to maintain your spray guns and help keep them lasting longer. **NEVER USE A METAL WIRE OR OTHER HARD INSTRUMENT TO CLEAN PRECISION DRILLED AIR PASSAGES. DAMAGED AIR PASSAGES WILL CAUSE A DISTORTED SPRAY PATTERN.**

- 4) Clean gaskets with solvent soaked rag. To prevent damage, do not immerse gaskets or spray gun in solvents as this is detrimental to the lubricants and packings.
- 5) After using water to clean out water based paints or materials, spray mineral spirits through the gun to prevent corrosion.
- 6) Lubricate gun after cleaning using light machine oil.

⚠ CAUTION Never use lubricants containing silicone as these lubricants can cause finish defects.

Apply light machine oil to: fluid needle packing, air valve packing, side port control packing, and trigger point. Coat fluid control spring and all threaded connections with petroleum jelly prior to storage.

CLEANING SPRAY GUNS USED WITH PAINT TANKS

⚠ WARNING Shut off air supply to paint tank and release pressure in the tank

- 1) Open the vent on the paint tank. If using an external mix cap, loosen cap slightly.
- 2) Reduce air pressure to 10 to 20 PSI. Hold a wadded piece of cloth over the tightly around the air cap opening(s) and pull the trigger. Air will back up through the fluid nozzle and force fluid out of the hose and back into the tank.
- 3) Pour paint from the tank and clean tank with solvent and rags.
- 4) Pour enough thinner into the tank to clean the hose and gun thoroughly. Close the tank and spray from the gun until the solvent comes out clean.
- 5) Remove fluid hose and blow it out thoroughly to remove all traces of solvent in the hose.

⚠ WARNING When blowing out the hose, the open end should be aimed away from any person to avoid blowing solvent into the eyes or on the skin causing possible injury.

AIR NOZZLE, FLUID TIP, NEEDLE ASSEMBLY

⚠ CAUTION To prevent damage to the fluid tip or fluid needle, be sure to either: 1) pull the trigger and hold while tightening or loosening the fluid tip, or 2) remove fluid needle adjusting screw to relieve spring pressure against needle collar.

- 1) All nozzles and needles are precision made and should be handled with care.
- 2) Except as described in “Fluid Needle Adjustment”, do not make any alterations in the gun. To do so will cause finishing difficulties.
- 3) To clean nozzles, soak them in solvent to dissolve any dried material, then blow them clean with compressed air.
- 4) Do not probe any of the holes in the nozzles with metal instruments. If probing is necessary, use only a tool that is softer than brass.

FLUID NEEDLE ADJUSTMENT

- 1) Loosen the needle cap.
- 2) Screw the needle assembly locknut out for more trigger movement, in for less trigger movement.
- 3) Adjust the needle assembly so that when the trigger moves, the air valve assembly moves 1/16” to 3/32” before the needle assembly moves.
- 4) Tighten the needle cap.

⚠ CAUTION Over tightening may damage the threads, which will make future adjustments difficult.



O-RINGS, SEALS, AND PACKING NUTS

- 1) Check and replace any damaged O-rings and seals. O-rings and seals can be wiped clean but not soaked in solvent.
- 2) Unscrew packing nuts and replace the packing ONLY if a leak will not stop when the nut is tightened. Do not over tighten a packing nut as this will restrict movement of the needle.
- 3) Reassemble in reverse order of above and use light machine oil to lubricate moving parts.

STORAGE

- 1) When not in use, turn the fluid adjustment knob counter-clockwise to open to reduce the spring tension on the needle fluid tip.
- 2) Spray gun **must be** cleaned and lightly lubricated prior to storage.

TROUBLESHOOTING

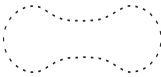
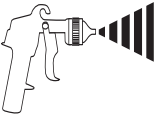
Problem Encountered	Possible Cause	Corrective Action
Heavy top or bottom pattern. 	Horn holes plugged. Obstruction on top or bottom of fluid tip. Cap and/or tip seat dirty.	Clean. Ream with non-metallic point. Clean. Clean.
Heavy right or left side pattern. 	Left or right side horn holes plugged. Dirt on left or right side of fluid tip.	Clean Ream with non-metallic point. Clean.
Heavy center pattern. 	Fluid pressure too high for atomization air (pressure feed). Material flow exceeds air cap's capacity. Spreader adjustment valve set too low. Material too thick.	Balance air and fluid pressure. Increase spray pattern width with spreader adjustment valve. Thin or lower fluid flow. Adjust. Increase pressure. Thin to proper consistency.
Split spray pattern. 	Atomization air pressure too high. Fluid pressure too low (pressure feed only). Spreader adjusting valve set too high.	Reduce at regulator or gun. Increase fluid pressure (increases gun handling speed). Adjust.
Spitting or pulsating spray. May also be accompanied by bubbling in the paint cup. 	Loose or damaged fluid tip/seat. Material level too low. Container tipped too far. Obstruction in fluid passage. Loose or broken fluid tube or fluid inlet nipple. Dry, loose or worn needle packing.	Tighten or replace. Refill. Hold more upright. Back flush with solvent. Tighten or replace. Replace packing.
Unable to get round spray.	Spreader adjustment screw not seating properly. Air cap retaining ring loose.	Clean or replace. Tighten.
Will not spray.	No air pressure at gun. Internal mix or pressure feed air cap and tip used with suction feed. Fluid pressure too low with internal mix cap and pressure tank. Fluid needle adjusting screw not open enough. Fluid tool heavy for suction feed.	Check air supply and air lines. Change to proper suction feed air cap and tip. Increase fluid pressure at tank. Open fluid needle adjusting screw. Thin material or change to pressure feed.
Starved spray pattern.	Inadequate material flow. Low atomization air pressure (suction feed). Too much atomization air pressure.	Back fluid adjusting screw out to first thread or increase fluid pressure at tank. Increase air pressure and rebalance gun. Reduce pressure.

TROUBLESHOOTING (Continued)

Problem Encountered	Possible Cause	Corrective Action
Excessive overspray	Gun too far from work surface. Improper stroking (arcing, gun motion too fast).	Adjust to proper distance. Move at moderate pace, parallel to work surface.
Excessive fog	Too much, or too fast-drying thinner. Too much atomization air pressure.	Remix properly. Reduce pressure.
Dry spray	Air pressure too high. Gun tip too far from work surface. Gun motion too fast. Gun out of adjustment.	Reduce air pressure. Adjust to proper distance. Slow down. Adjust.
Fluid leaking from packing nut	Packing nut loose. Packing worn or dry.	Tighten, do not bind needle. Replace or lubricate.
Fluid leaking or dripping from front of pressure feed gun	Packing nut too tight. Dry packing. Fluid tip or needle worn or damaged. Foreign matter in tip. Fluid needle spring broken. Wrong size needle or tip.	Adjust. Lubricate. Replace tip. Clean. Replace. Replace.
Runs and sags	Too much material flow. Material too thin. Gun tilted on an angle, or gun motion too slow.	Adjust gun or reduce fluid pressure. Mix properly or apply light coats. Hold gun at right angle to work and adapt to proper gun technique.
Thin, sandy coarse finish drying before it flows out	Gun too far from surface. Too much air pressure. Improper thinner being used.	Check distance. Normally about 8". Reduce pressure and check spray pattern. Follow paint manufacturer's mixing instructions.
Thick, dimpled finish "orange peel"	Gun too close to surface. Too much material coarsely atomized. Air pressure too low. Improper thinner being used. Material not properly mixed. Surface rough, oily, dirty.	Check distance. Normally about 8". Increase air pressure or reduce fluid pressure. Increase air pressure or reduce fluid pressure. Follow paint manufacturer's mixing instructions. Follow paint manufacturer's instructions. Properly clean and prepare surface.

TOUCH UP GUN PARTS BREAKDOWN

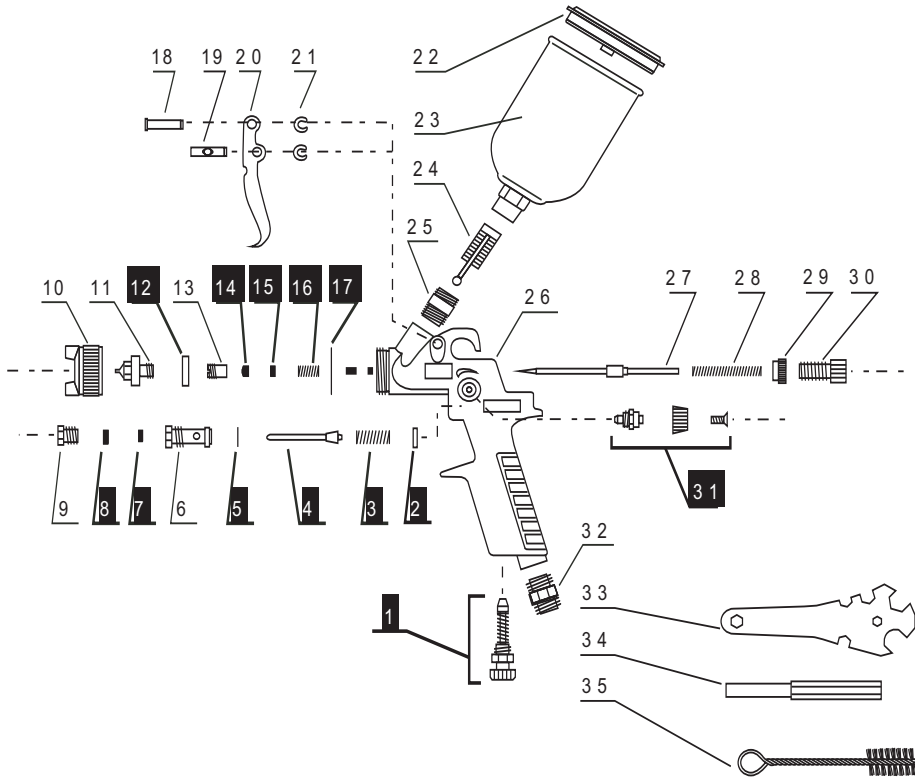

Item numbers in **REVERSE TYPE** included in 19910 Spray Gun Rebuild Kit

Ln #	Description	Qty	Ln #	Description	Qty
1	Air Adjustment Valve	1	19	Trigger Pin- Fluid Needle	1
2	Gasket	1	20	Trigger	1
3	Air Valve Spring	1	21	Retaining Ring	2
4	Air Valve Piston Shaft	1	22	Lid	1
5	O-Ring	1	23	Cup	1
6	Air Valve Seat	1	24	Fluid Filter	1
7	O-Ring	1	25	Fluid Inlet Fitting	1
8	Pliable Packing Washer	1	26	Gun Body	1
9	Air Valve Packing Nut	1	27	Fluid Needle	1
10	Air Cap	1	28	Fluid Needle Spring	1
11	Fluid Nozzle	1	29	Fluid Adjustment Locking Ring	1
12	Air Manifold Spacer	1	30	Fluid Adjustment Knob	1
13	Retention Screw	1	31	Pattern Adjustment Valve	1
14	Paint Needle Washer	1	32	Air Inlet Fitting	1
15	Sealing Washer	1	33	Gun Wrench	1
16	Locking Spring	1	34	Internal/External Hex Wrench	1
17	O-Ring	1	35	Brush	1
18	Trigger Pin - Pivot	1			

PRODUCTION GUN PARTS BREAKDOWN

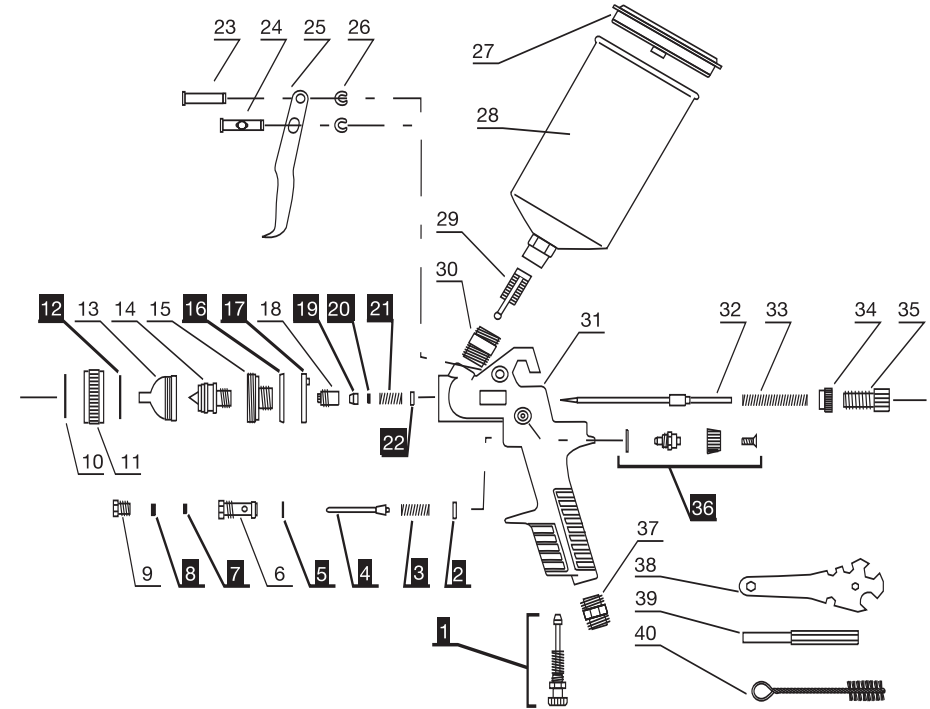

Item numbers in **REVERSE TYPE** included in 19909 Spray Gun Rebuild Kit

Ln #	Description	Qty	Ln #	Description	Qty
1	Air Adjustment Valve	1	21	Locking Spring	1
2	Gasket	1	22	Gasket	1
3	Air Valve Spring	1	23	Trigger Pin- Pivot	1
4	Air Valve Piston Shaft	1	24	Trigger Pin- Fluid Needle	1
5	O-Ring	1	25	Trigger	1
6	Air Valve Seat	1	26	Retaining Ring	2
7	O-Ring	1	27	Lid	1
8	Pliable Packing Washer	1	28	Cup	1
9	Air Valve Packing Nut	1	29	Fluid Filter	1
10	Air Cap Retention Ring	1	30	Fluid Inlet Fitting	1
11	Air Cap Locking Ring	1	31	Gun Body	1
12	Air Cap Washer	1	32	Fluid Needle	1
13	Air Cap	1	33	Fluid Needle Spring	1
14	Fluid Nozzle	1	34	Fluid Adjustment Locking Ring	1
15	Air Manifold	1	35	Fluid Adjustment Knob	1
16	Tapered Washer	1	36	Pattern Adjustment Valve	1
17	Air Manifold Spacer	1	37	Air Inlet Fitting	1
18	Retention Screw	1	38	Gun Wrench	1
19	Paint Needle Washer	1	39	Internal/External Hex Wrench	1
20	Sealing Washer	1	40	Brush	1

ONE YEAR LIMITED WARRANTY

Star Asia-USA, LLC (hereinafter "seller") warrants to the original purchaser only, that this product will be free from defects in material or workmanship for a period of one year from date of purchase for home domestic use.

Warranty Performance

Warranty coverage is conditioned upon purchaser furnishing seller or its authorized service center with adequate written proof of the original purchase date. Products returned, freight prepaid and insured, to our factory or to an Authorized Service Center will be inspected and repaired or replaced, at seller's option, free of charge if found to be defective and subject to warranty. Defective parts not subject to normal wear and tear will be repaired or replaced, at our option during the above stated warranty periods. In any event, reimbursement is limited to the purchase price paid. Other than the postage and insurance requirement, no charge will be made for repairs or replacements covered by this warranty. Under no circumstances shall the manufacturer bear any responsibility for loss of the unit, loss of time or rental, inconvenience, commercial loss or consequential damages. There are no warranties which extend beyond the description of the face hereof.

Exclusions

This warranty does not cover parts damaged due to normal wear, abnormal conditions, misapplication, misuse, abuse, accidents, operation at other than recommended pressures or temperatures, improper storage or freight damage. Parts damaged or worn by operation in dusty environments are not warranted. Failure to follow recommended operating and maintenance procedures also voids warranty.

Additional items not covered under this warranty: product failure caused by rain, excessive humidity, corrosive environments or other contaminants; cosmetic defects that do not interfere with product's functionality.

This warranty shall not apply when: the product has been used for commercial or rental purposes; defects in materials or workmanship or damages result from repairs or alterations which have been made or attempted by others or the unauthorized use of nonconforming parts; this damage is due to abuse, improper maintenance, neglect or accident; or the damage is due to use of the product after partial failure or use with improper accessories. Warranty does not apply to accessory items.

Seller will not be liable for: labor charges, loss or damage resulting from improper operation, maintenance or repairs made by persons other than a Star Asia-USA, LLC Authorized Service Center.

The use of other than genuine Star Asia-USA, LLC Repair Parts will void warranty.

Warranty Disclaimers

NO WARRANTY, ORAL OR WRITTEN, OTHER THAN THE ABOVE WARRANTY IS MADE WITH REGARD TO THIS PRODUCT, ANY IMPLIED WARRANTIES OF SELLER REGARDING THIS PRODUCT INCLUDING BUT NOT LIMITED TO, THE IMPLIED WARRANTIES OF MERCHANTABILITY OR FITNESS FOR A PARTICULAR PURPOSE, ARE EXCLUDED. BUYER'S OR USER'S REMEDIES ARE SOLELY AND EXCLUSIVELY AS STATED ABOVE. STAR ASIA-USA, LLC SHALL IN NO EVENT BE LIABLE FOR INCIDENTAL, CONSEQUENTIAL, INDIRECT, OR SPECIAL DAMAGES. IN NO EVENT, WHETHER AS A RESULT OF A BREACH OF CONTRACT, WARRANTY, TORT (INCLUDING NEGLIGENCE) OR OTHERWISE, SHALL SELLER'S LIABILITY EXCEED THE PRICE OF THE PRODUCT WHICH HAS GIVEN RISE TO THE CLAIM OR LIABILITY. ANY LIABILITY CONNECTED WITH THE USE OF THIS PRODUCT SHALL TERMINATE UPON THE EXPIRATION OF THE WARRANTY PERIODS SPECIFIED ABOVE.

Limitations on Warranty Disclaimers

Any implied warranties shall be limited in duration to one year from the date of purchase. In some states of the U.S.A. and in some provinces of Canada there is no limitation for how long an implied warranty is valid, so the aforementioned limitation may not apply to you.

In no event shall seller be liable for any incidental or consequential damages (including but not limited to liability for loss of profits) arising from the sale or use of this product. In some states of the U.S.A. and in some provinces of Canada the exclusion or limitation of incidental or consequential damages is not allowed, so the aforementioned limitation or exclusion may not apply to you.

This limited warranty gives you specific legal rights, and you may also have other rights which vary from state to state in the U.S.A., Canada and the Commonwealth of Puerto Rico. For warranty coverage within other countries, contact your local Star Asia-USA, LLC dealer or importer.

Distributed by Star Asia-USA, LLC
P.O. Box 58399, Renton, WA 98058
Consumer Service: 800-386-0191
e-mail: info@titan-us.com
©2005 Star Asia-USA, LLC